

# TC MGUARD RS4000 4G ATT VPN - Router



1010463

<https://www.phoenixcontact.com/us/products/1010463>

Please be informed that the data shown in this PDF document is generated from our online catalog. Please find the complete data in the user documentation. Our general terms of use for downloads are valid.



Security appliance, version for AT&T (US), WAN and 4G mobile network interface, SD card slot, 10 VPN tunnels, intelligent firewall with full scope of functions, router with NAT/1:1 NAT, optional CIFS Integrity Monitoring, 4 port Managed Switch

## Product description

The TC MGUARD... security appliances are industrial mobile network routers with mGuard technology. As such, the routers offer a remote maintenance infrastructure for the secure connection of machines and systems via the Internet. A high-speed mobile network interface and a 4-port switch are integrated into a compact metal housing. Secure remote communication on a global scale takes place via 4G LTE as well as UMTS and CDMA networks. With the help of an SD card as a configuration memory, the devices can be quickly and easily started up or replaced. The devices have a buffered realtime clock and Trusted Platform Module (TPM) for secure key generation and management.

## Your advantages

- Integrated 4-port switch
- Maximum security with IPsec protocol on Layer 3
- Web-based management, SNMP
- Replaceable configuration memory
- RS-232 interface with COM server function for integrating serial devices
- Flexible routing
- Up to 10 parallel VPN tunnels (up to 250 possible with additional license as an option)
- Supports current certificates such as x509.v3
- Stateful inspection firewall for dynamic filtering
- Extended temperature rating

## Commercial data

Item number	1010463
Packing unit	1 pc
Minimum order quantity	1 pc
Sales key	DN25
Product key	DNC424
Catalog page	Page 405 (C-6-2019)
GTIN	4055626484150
Weight per piece (including packing)	647.8 g
Weight per piece (excluding packing)	645.65 g
Customs tariff number	85176200
Country of origin	DE

# TC MGUARD RS4000 4G ATT VPN - Router



1010463

<https://www.phoenixcontact.com/us/products/1010463>

## Technical data

### Dimensions

Width	45 mm
Height	130 mm
Depth	114 mm

### Notes

#### Note on application

Note on application	Only for industrial use
---------------------	-------------------------

#### Utilization restriction

CCCex note	Use in potentially explosive areas is not permitted in China.
------------	---

### Material specifications

Material (Housing)	Metal
--------------------	-------

### Interfaces

Signal	Ethernet
Web server	yes
Basic functions	Router with intelligent firewall and VPN for 10 tunnels (up to 250 supported with optional additional license), CIFS Integrity Monitoring (as an option), metal housing, slot for SD memory card

#### Data: Ethernet interface, 10/100Base-T(X) in accordance with IEEE 802.3

Transmission speed	10/100 Mbps (auto negotiation)
Connection method	RJ45
No. of channels	6
Transmission length	100 m (shielded twisted pair)
Protocols supported	TCP/IP, UDP/IP, FTP, HTTP
Auxiliary protocols	ARP, DHCP, PING (ICMP), SNMP V1, SMTP

#### Data: V.24 (RS-232) interface in acc. with ITU-T V.28, EIA/TIA-232, DIN 66259-1

Serial transmission speed	9.6; 19.2; 38.4; 57.6; 115.2 kbps
Connection method	D-SUB 9 plug
Transmission length	15 m
File format/coding	UART/NRZ: 8 Data, 1/2 Stop, None/Even/Odd Parity
Data flow control/protocols	Software handshake, Xon/Xoff or hardware handshake RTS/CTS

### Wireless

Interface description	LTE (FDD) / UMTS
Frequency range	700 MHz (LTE B13 / B17)
	850 MHz (LTE B5)
	1700 MHz (LTE B4)
	1900 MHz (LTE B2)

# TC MGUARD RS4000 4G ATT VPN - Router



1010463

<https://www.phoenixcontact.com/us/products/1010463>

	850 MHz (UMTS/HSPA B5)
	1900 MHz (UMTS/HSPA B2)
Data rate	≤ 150 Mbps (LTE, DL)
	≤ 50 Mbps (LTE, UL)
Antenna	50 Ω impedance SMA antenna socket
Antenna connection method	SMA (female)
SIM Interface	1.8 volt, 3 volt
UMTS	HSPA 3GPP R9
LTE	CAT4
Country support	USA

## System properties

### Functionality

Basic functions	Router with intelligent firewall and VPN for 10 tunnels (up to 250 supported with optional additional license), CIFS Integrity Monitoring (as an option), metal housing, slot for SD memory card
-----------------	--

### System requirements

Supported browsers	HTTPS support required
--------------------	------------------------

## Input data

### Digital

Description of the input	Digital input
Number of inputs	3
Voltage input signal	10 V DC ... 30 V DC
Current input signal	5 mA

## Output data

### Signal

Output name	Digital output, resistive load
Number of outputs	3
Voltage output signal	10 V DC ... 30 V DC (depending on the operating voltage)
Current output signal	≤ 125 mA (Short-circuit-proof)

## Product properties

Product type	Security router for the DIN rail
Application	Ethernet
	RS-232
MTTF	532 Years (SN 29500 standard, temperature 25°C, operating cycle 21%)
	250 Years (SN 29500 standard, temperature 40°C, operating cycle 34.25%)
	104 Years (SN 29500 standard, temperature 40°C, operating cycle 100%)

## Security functions

1:1 Network Address Translation (NAT) in the VPN	supported
Number of VPN tunnels	10 (up to 250 tunnels with additional license as an option)
Authentication	X.509v3 certificates with RSA or PSK
Data integrity	MD5, SHA-1
Dynamic Host Configuration Protocol (DHCP) support	Server or Relay Agent
Filtering	MAC addresses
	IP addresses
	Ports
	Protocols
Firewall data throughput	max. 124 Mbps (Router mode, default firewall rules, bidirectional throughput)
	max. 58 Mbps (Stealth mode, default firewall rules, bidirectional throughput)
Firewall rules	Configurable stateful inspection firewall with full scope of functions
Basic functions	Router with intelligent firewall and VPN for 10 tunnels (up to 250 supported with optional additional license), CIFS Integrity Monitoring (as an option), metal housing, slot for SD memory card
Internet Protocol Security (IPsec) mode	ESP tunnel / ESP transport
Link Layer Discovery Protocol (LLDP)	As per protocol 802.2
Network Time Protocol (NTP) client	Client
Remote Syslog Logging	on external server
Routing	Standard routing
	NAT
	1:1-NAT
	Port forwarding
Protection against	IP spoofing, DoS and Syn Flood Protection
Encryption methods	DES, 3DES, AES-128, -192, -256
Virtual private network (VPN) throughput	max. 40 Mbps (Router)
	max. 26 Mbps (Stealth mode, VPN bidirectional throughput)

## Electrical properties

Electrical isolation	VCC // PE
Mains type	Cellular communication
Test voltage data interface/data interface	1 kV (50 Hz, 1 min., manufacturer's declaration)
Test voltage data interface/power supply	1 kV (50 Hz, 1 min., manufacturer's declaration)

## Supply

Supply voltage range	11 V DC ... 36 V DC (via pluggable COMBICON screw terminal block)
Typical current consumption	< 320 mA (24 V DC)
Max. current consumption	1.8 A (at 11 V DC (incl. 3 x 125 mA for the outputs))

## Function

Management	Web-based management, SNMP
------------	----------------------------

## Connection data

### Supply

Conductor cross section flexible, with ferrule without plastic sleeve	0.25 mm <sup>2</sup> ... 2.5 mm <sup>2</sup>
Conductor cross section, flexible, with ferrule, with plastic sleeve	0.25 mm <sup>2</sup> ... 2.5 mm <sup>2</sup>
Conductor cross section, flexible	0.20 mm <sup>2</sup> ... 2.50 mm <sup>2</sup>
Conductor cross section, rigid	0.20 mm <sup>2</sup> ... 2.50 mm <sup>2</sup>
Conductor cross section AWG	24 ... 14
Stripping length	7.00 mm
Tightening torque	0.56 Nm ... 0.79 Nm

## Environmental and real-life conditions

### Ambient conditions

Degree of protection	IP20 (Manufacturer's declaration)
Ambient temperature (operation)	-40 °C ... 60 °C
Ambient temperature (storage/transport)	-40 °C ... 70 °C
Altitude	≤ 5000 m (For restrictions, see the manufacturer's declaration for altitude operation)
Permissible humidity (operation)	5 % ... 95 % (non-condensing)

## Standards and regulations

Free from substances that could impair the application of coating	in accordance with VW-AUDI-Seat central standard P-VW 3.10.7 57 65 0
---	--

## Approvals

### UL, USA/Canada

Identification	Class I, Zone 2, AEx nA IIC T4 / Ex nA IIC T4 Gc Class I, Div. 2, Groups A, B, C, D T4
----------------	---

### Corrosive gas test

Identification	ISA-S71.04-1985 G3 Harsh Group A
----------------	----------------------------------

### Wireless approval USA, FCC

Certificate	N7NHL7588
-------------	-----------

## Mounting

Mounting type	DIN rail mounting
---------------	-------------------

## EMC data

Electromagnetic compatibility	Conformance with RED Directive 2014/53/EU
-------------------------------	---

### Electrostatic discharge

Standards/regulations	EN 61000-4-2
-----------------------	--------------

# TC MGUARD RS4000 4G ATT VPN - Router



1010463

<https://www.phoenixcontact.com/us/products/1010463>

## Electrostatic discharge

Contact discharge	± 6 kV (Test Level 3)
Discharge in air	± 8 kV (Test Level 3)
Comments	Criterion B

## Electromagnetic HF field

Standards/regulations	EN 61000-4-3
-----------------------	--------------

## Electromagnetic HF field

Frequency range	80 MHz ... 3 GHz (Test Level 3)
Field intensity	10 V/m
Comments	Criterion A

## Fast transients (burst)

Standards/regulations	EN 61000-4-4
-----------------------	--------------

## Fast transients (burst)

Input	± 2.2 kV (Test Level 3)
Signal	± 2.2 kV (Test Level 3)
Comments	Criterion B

## Surge current load (surge)

Standards/regulations	EN 61000-4-5
-----------------------	--------------

## Surge current load (surge)

Input	± 0.5 kV (DC supply)
Signal	± 1 kV (Data line, asymmetrical)
Comments	Criterion B

## Conducted interference

Standards/regulations	EN 61000-4-6
-----------------------	--------------

## Conducted interference

Frequency range	0.15 MHz ... 80 MHz
Comments	Criterion A
Voltage	10 V

## Emitted interference

Standards/regulations	EN 61000-6-4
Radio interference voltage in acc. with EN 55011	EN 55011 class A industrial area of application
Emitted radio interference in acc. with EN 55011	EN 55011 class A industrial area of application

## Criteria

Criterion A	Normal operating behavior within the specified limits.
Criterion B	Temporary impairment to operational behavior that is corrected by the device itself.

# TC MGUARD RS4000 4G ATT VPN - Router



1010463

<https://www.phoenixcontact.com/us/products/1010463>

## Drawings

### Schematic diagram

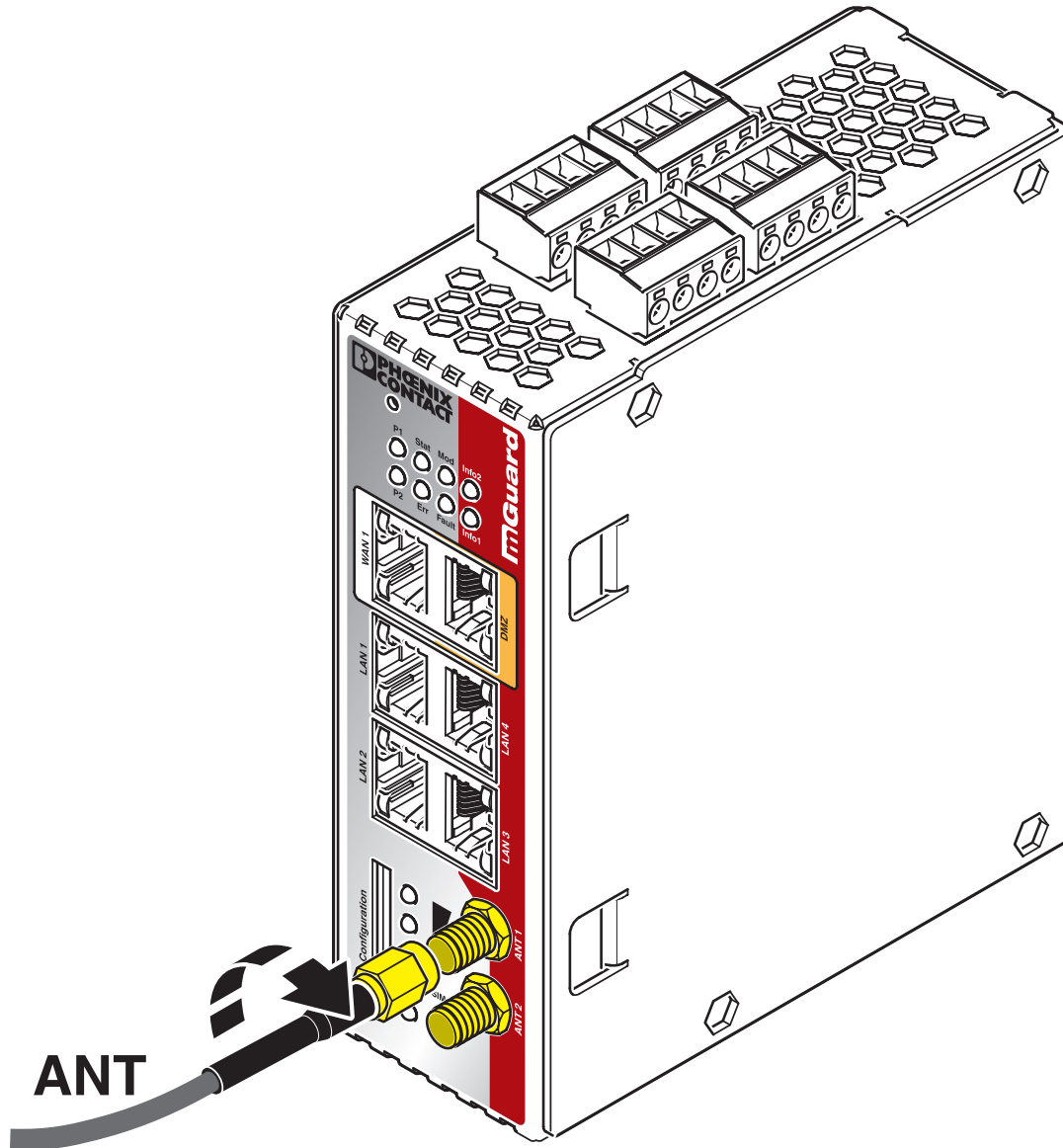

Connect the antenna

# TC MGUARD RS4000 4G ATT VPN - Router



1010463

<https://www.phoenixcontact.com/us/products/1010463>

Schematic diagram

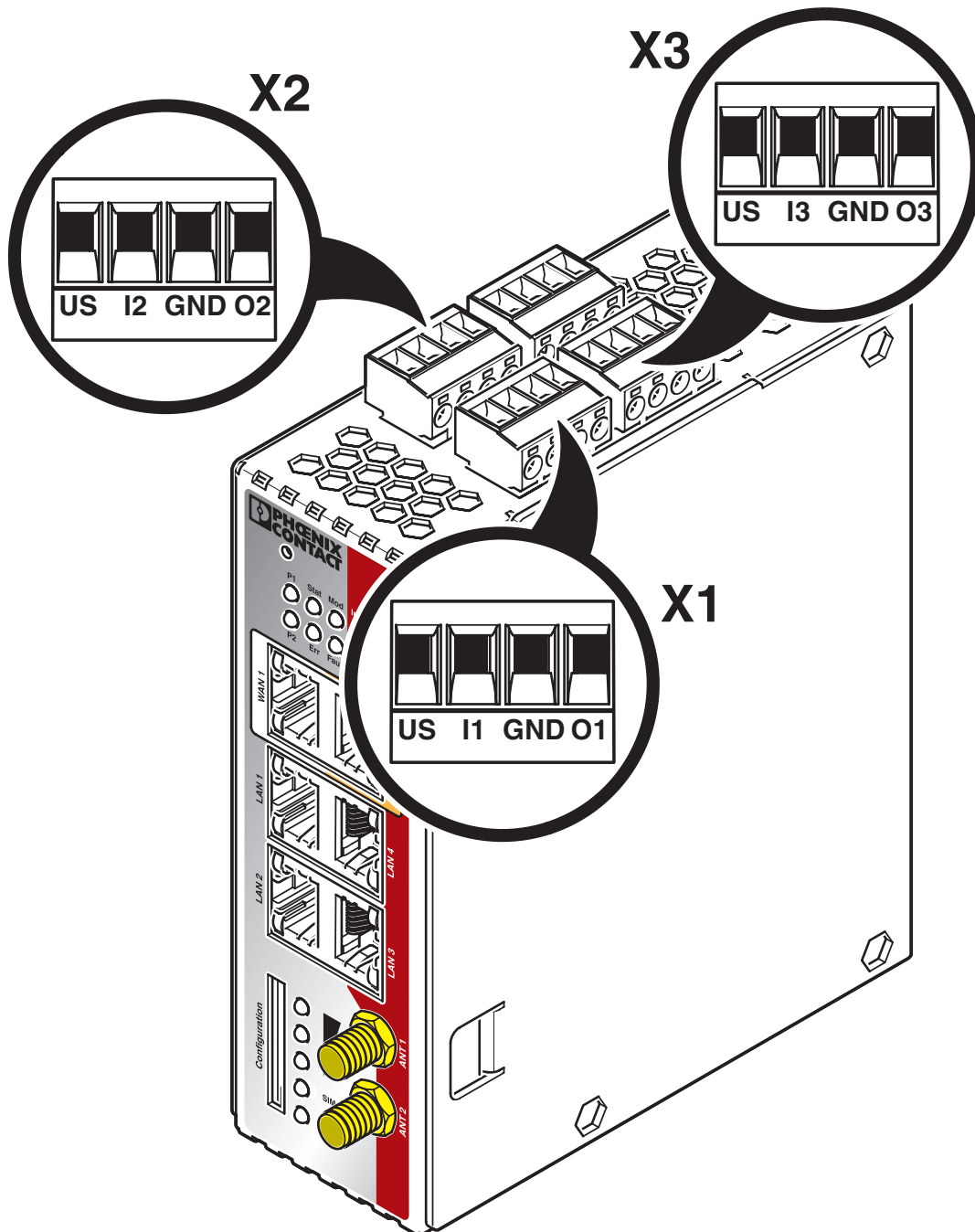

Service and signal contacts



1010463

<https://www.phoenixcontact.com/us/products/1010463>

Schematic diagram

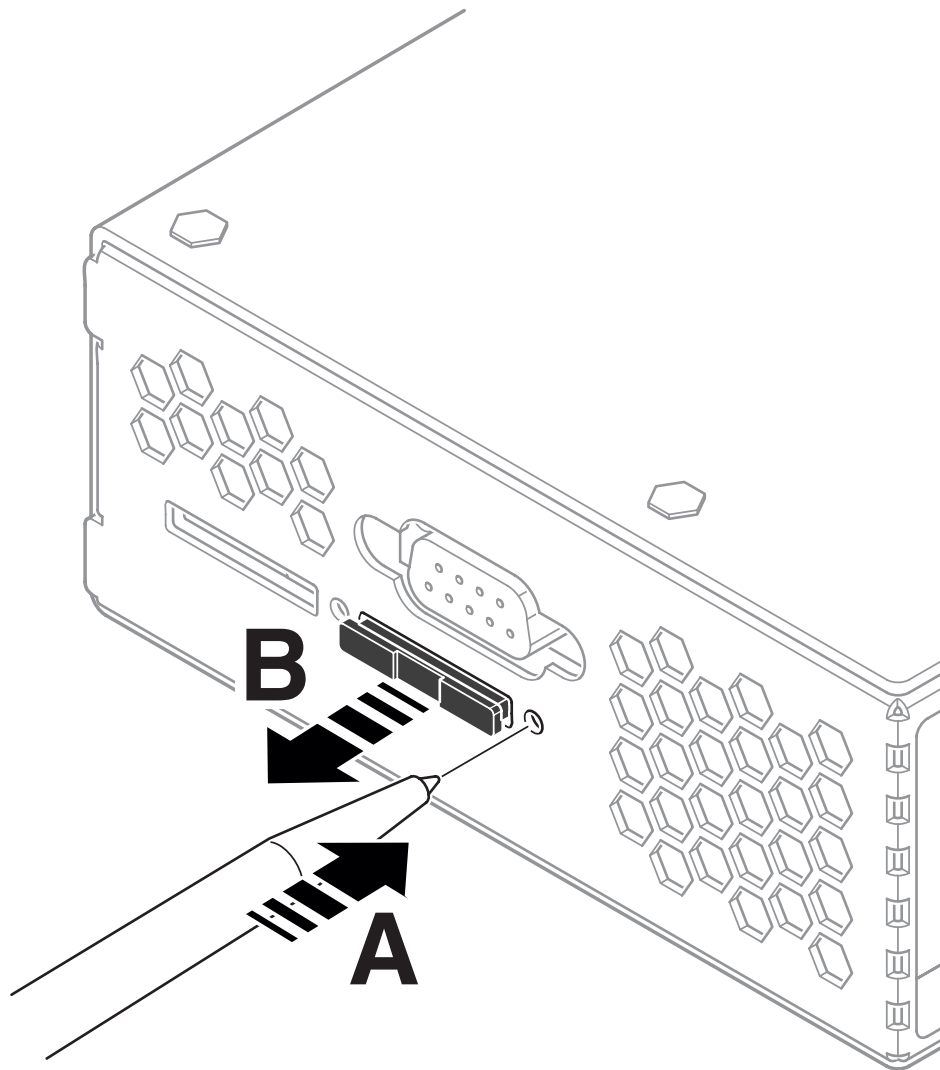

Remove SIM card holder

# TC MGuard RS4000 4G ATT VPN - Router



1010463

<https://www.phoenixcontact.com/us/products/1010463>

Schematic diagram

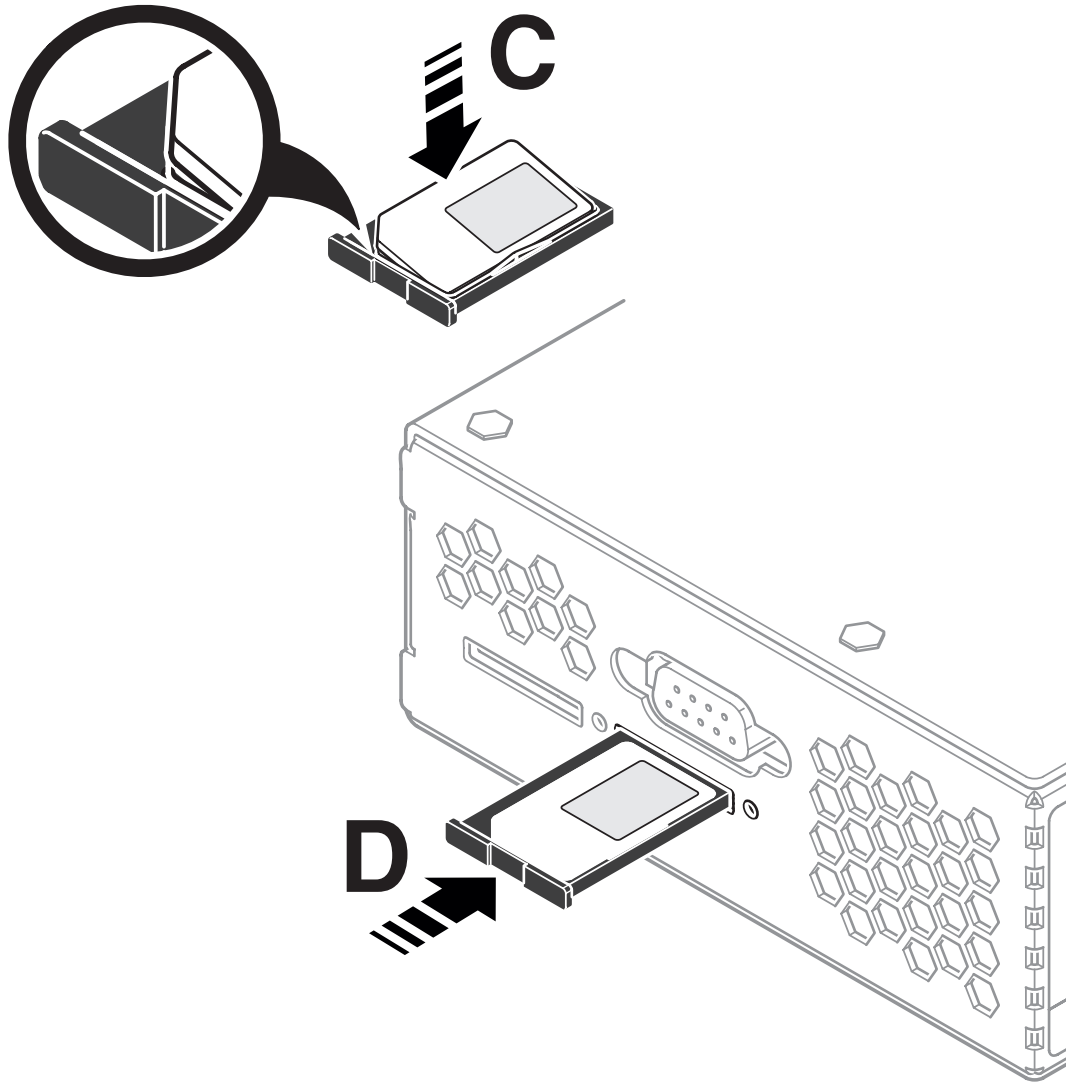

Insert the SIM card

# TC MGUARD RS4000 4G ATT VPN - Router

1010463

<https://www.phoenixcontact.com/us/products/1010463>



Schematic diagram

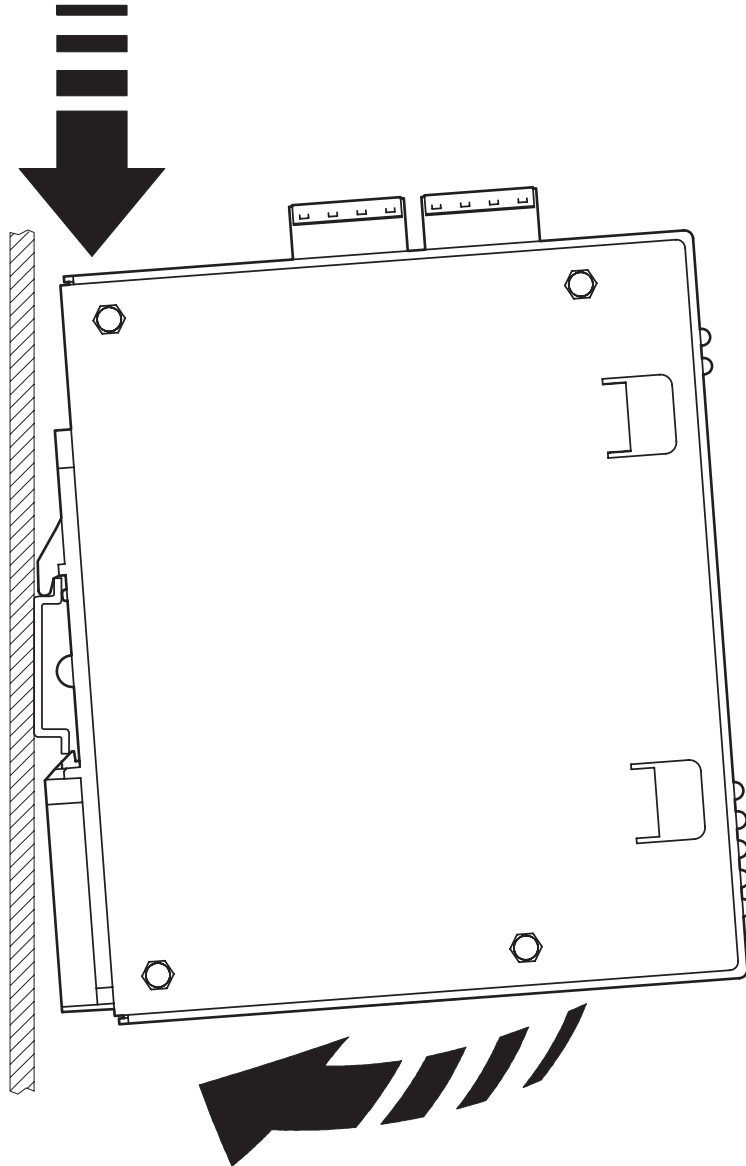

Mounting

# TC MGUARD RS4000 4G ATT VPN - Router

1010463

<https://www.phoenixcontact.com/us/products/1010463>

Schematic diagram

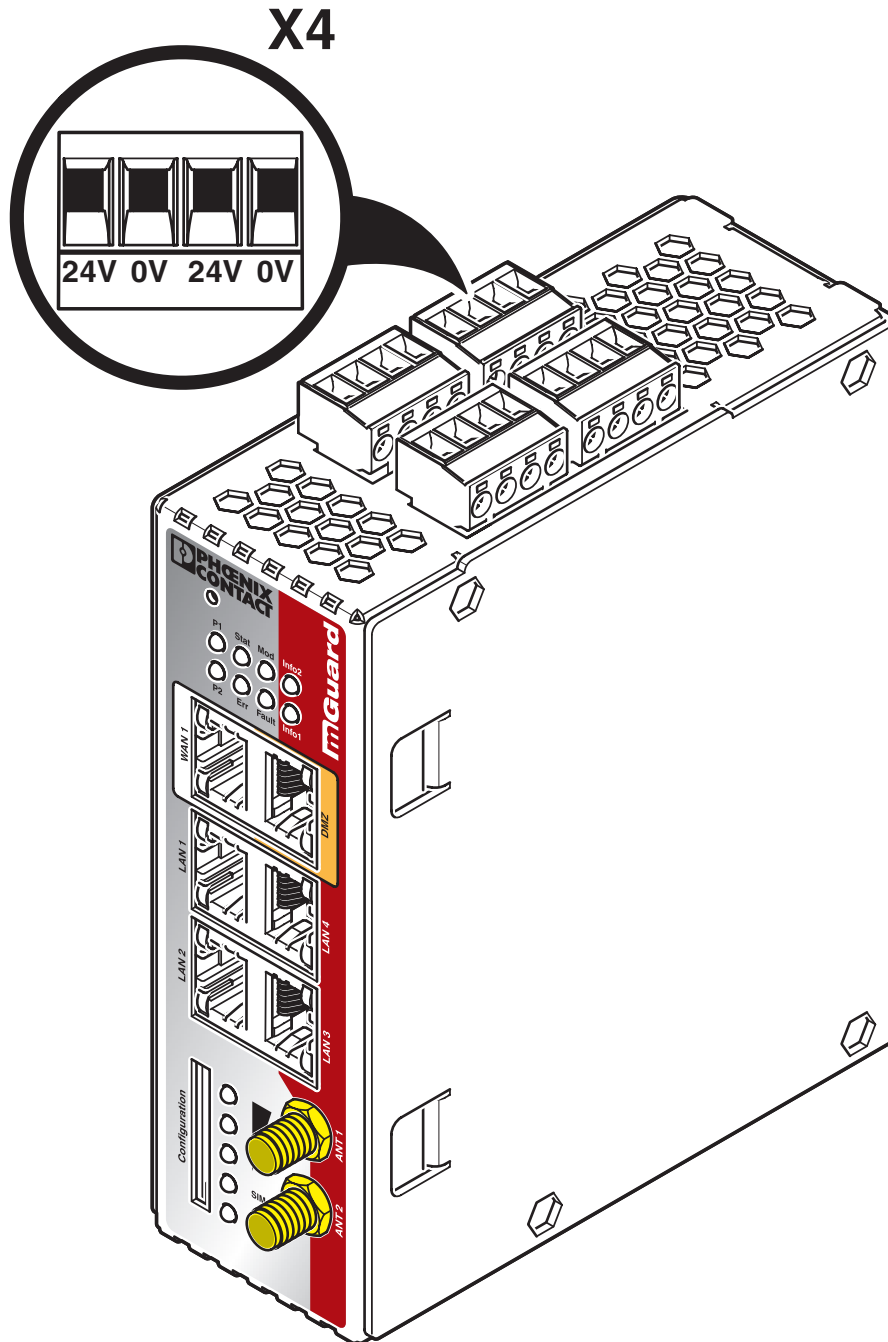

Connecting the supply voltage

# TC MGUARD RS4000 4G ATT VPN - Router





1010463

<https://www.phoenixcontact.com/us/products/1010463>

## Approvals

To download certificates, visit the product detail page: <https://www.phoenixcontact.com/us/products/1010463>

 **UL Listed**  
Approval ID: E238705

 **cUL Listed**  
Approval ID: E238705

 **cUL Listed**  
Approval ID: E366272

 **UL Listed**  
Approval ID: FILE E 366272

**cULus Listed**

**cULus Listed**

# TC MGuard RS4000 4G ATT VPN - Router



1010463

<https://www.phoenixcontact.com/us/products/1010463>

## Classifications

### ECLASS

ECLASS-11.0	19170406
ECLASS-12.0	19170406
ECLASS-13.0	19170406

### ETIM

ETIM 9.0	EC001478
----------	----------

### UNSPSC

UNSPSC 21.0	43222600
-------------	----------

# TC MGUARD RS4000 4G ATT VPN - Router



1010463

<https://www.phoenixcontact.com/us/products/1010463>

## Environmental product compliance

### EU RoHS

Fulfills EU RoHS substance requirements	Yes
Exemption	6(c), 7(a), 7(c)-I

### China RoHS

Environment friendly use period (EFUP)	EFUP-50
	An article-related China RoHS declaration table can be found in the download area for the respective article under "Manufacturer declaration". For all articles with EFUP-E, no China RoHS declaration table issued and required.

### EU REACH SVHC

REACH candidate substance (CAS No.)	Lead(CAS: 7439-92-1)
-------------------------------------	----------------------

Phoenix Contact 2024 © - all rights reserved  
<https://www.phoenixcontact.com>

Phoenix Contact USA  
586 Fulling Mill Road  
Middletown, PA 17057, United States  
(+717) 944-1300  
[info@phoenixcon.com](mailto:info@phoenixcon.com)